

RCPE130 MINIMUM PIPE SIZING FOR 60 DEGREE TIRE CONTACT

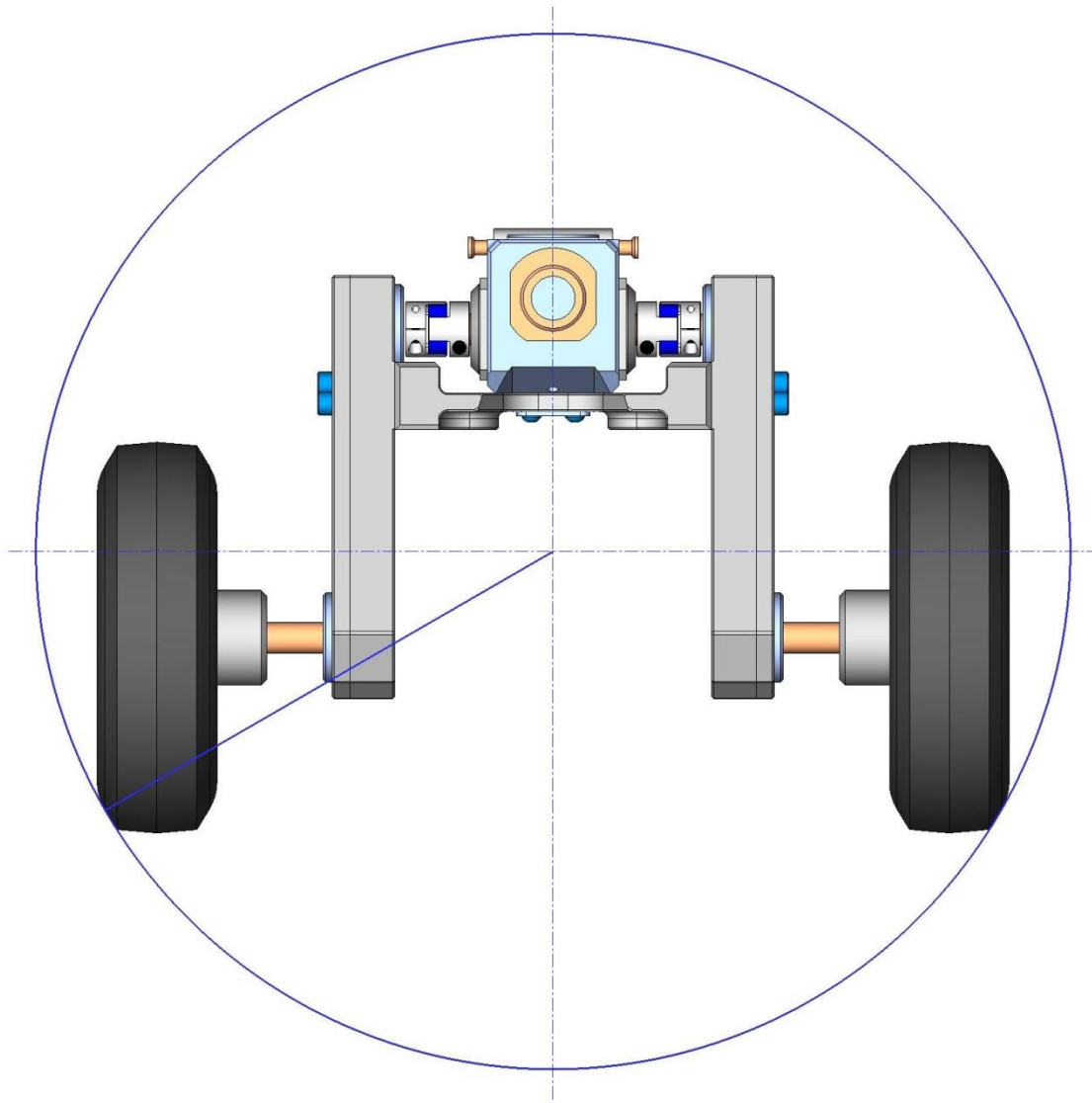

PIPE DIAMETER	121 mm Leg Short Axle	150 mm Leg Short Axle	195 mm Leg Extended Axle
108 mm Diameter Wheels	372 mm (14.62 inches)	372 mm (14.62 inches)	441 mm (17.35 inches)
133 mm Diameter Wheels	398 mm (15.65 inches)	398 mm (15.65 inches)	467 mm (18.38 inches)
214 mm Diameter Wheels	499 mm (19.65 inches)	499 mm (19.65 inches)	554 mm (21.79 inches)